













DBL 104

FIRE PLAN

- Breathing Apparatus 
- Co2 Extinguisher 
- Dry Chem Extinguisher 
- Emergency Eye Flush Station 
- Emergency Fuel Shutoff 
- Emergency Shutdown 
- Fire Axe 
- Life Ring 
- First Aid Kit 
- Spill Response Kit 
- Life Jacket 
- Smoke Detector 

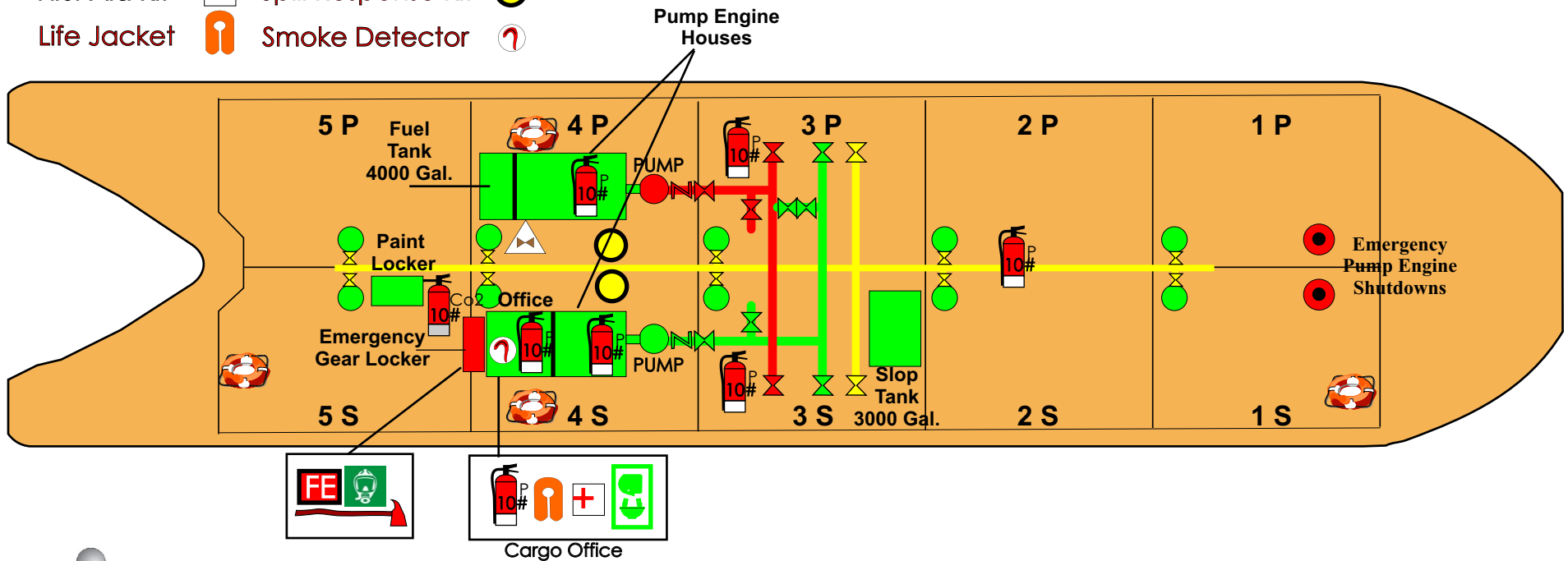

399'11" X 74' X 25'
OPA 90 DOUBLE HULL BARGE
YEAR BUILT : 2007
OFFICIAL No. 1193787
GROSS TONS: 6,214
PUMPS - 2 DEEPWELLS

CAPACITY - 106,451 BARRELS
@ 100%

1 PORT - 10,238	1 STARB - 10,238
2 PORT - 10,835	2 STARB - 10,835
3 PORT - 10,835	3 STARB - 10,835
4 PORT - 10,835	4 STARB - 10,835
5 PORT - 10,482	5 STARB - 10,482