











DBL 31 FIRE PLAN

-  Smoke Alarm
-  Co2 Extinguisher
-  Fire Axe
-  Dry Chem Extinguisher
-  100# B-V Dry Chemical Extinguisher
-  Life Ring & Life Ring w/Light
-  First Aid Kit
-  Survival Suit
-  Life Jacket
-  Defibrillator



249.5' X 64' X 16'		CAPACITY - 33,207.82 BARRELS	
Double Hull Barge		1 PORT - 3881.79	1 STARB - 3879.01
YEAR BUILT : 1999		2 PORT - 3884.12	2 STARB - 3869.14
OFFICIAL No. 1079242		3 PORT - 1662.12	3 STARB - 1653.71
GROSS TONS: 2146		4 PORT - 3309.14	4 STARB - 3306.79
PUMPS - 3 DEEPWELLS		5 PORT - 3388.11	5 STARB - 3873.89

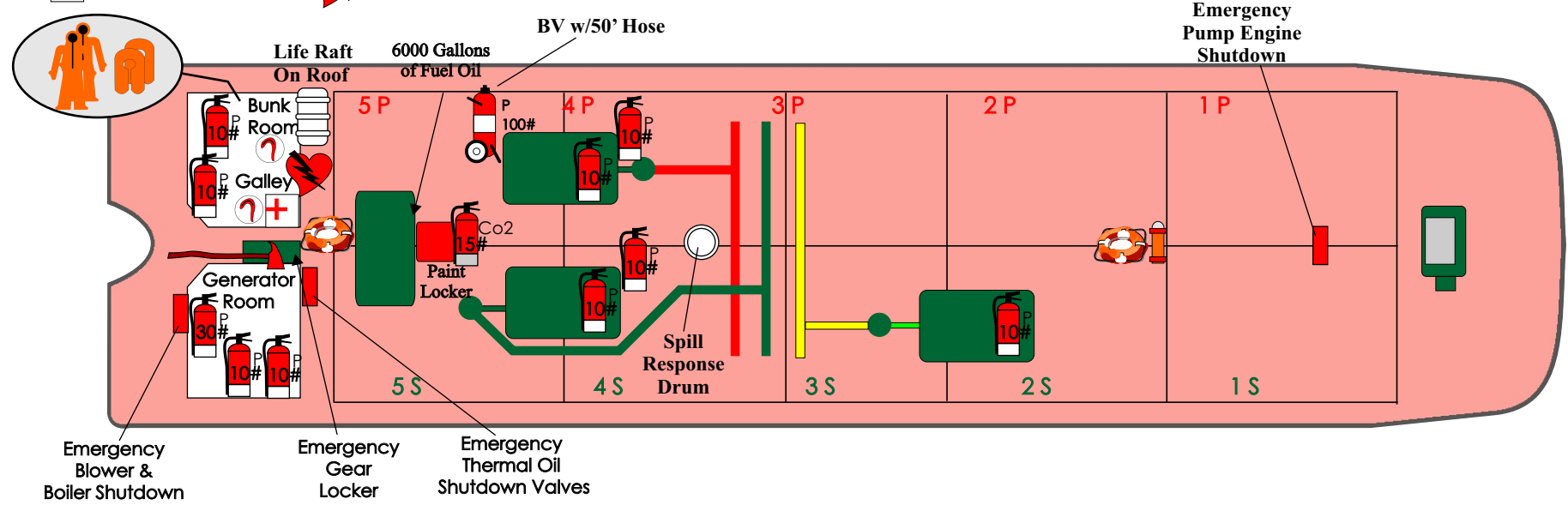

6/2013